



# Smart Interactive Whiteboard

## User's Manual





# Foreword

## General

This manual introduces the functions and operations of the smart interactive whiteboard (hereinafter referred to as "the whiteboard"). Read carefully before using the whiteboard, and keep the manual safe for future reference.

## Safety Instructions

The following signal words might appear in the manual.

Signal Words	Meaning
 WARNING	Indicates a medium or low potential hazard which, if not avoided, could result in slight or moderate injury.
 CAUTION	Indicates a potential risk which, if not avoided, could result in property damage, data loss, reductions in performance, or unpredictable result.
 NOTE	Provides additional information as a supplement to the text.

## Revision History

Version	Revision Content	Release Time
V1.0.4	Updated the packing list.	October 2023
V1.0.3	Updated the software functions.	August 2023
V1.0.2	Updated ports.	February 2023
V1.0.1	Updated important safeguard and warnings.	October 2022
V1.0.0	First release.	September 2022

## Privacy Protection Notice

As the device user or data controller, you might collect the personal data of others such as their face, fingerprints, and license plate number. You need to be in compliance with your local privacy protection laws and regulations to protect the legitimate rights and interests of other people by implementing measures which include but are not limited: Providing clear and visible identification to inform people of the existence of the surveillance area and provide required contact information.

## About the Manual

- The manual is for reference only. Slight differences might be found between the manual and the product.
- We are not liable for losses incurred due to operating the product in ways that are not in compliance with the manual.

- The manual will be updated according to the latest laws and regulations of related jurisdictions. For detailed information, see the paper user's manual, use our CD-ROM, scan the QR code or visit our official website. The manual is for reference only. Slight differences might be found between the electronic version and the paper version.
- All designs and software are subject to change without prior written notice. Product updates might result in some differences appearing between the actual product and the manual. Please contact customer service for the latest program and supplementary documentation.
- There might be errors in the print or deviations in the description of the functions, operations and technical data. If there is any doubt or dispute, we reserve the right of final explanation.
- Upgrade the reader software or try other mainstream reader software if the manual (in PDF format) cannot be opened.
- All trademarks, registered trademarks and company names in the manual are properties of their respective owners.
- Please visit our website, contact the supplier or customer service if any problems occur while using the device.
- If there is any uncertainty or controversy, we reserve the right of final explanation.

# Important Safeguards and Warnings

This section introduces content covering the proper handling of the whiteboard, hazard prevention, and prevention of property damage. Read carefully before using the whiteboard, and comply with the guidelines when using it.

## Storage Requirements



- Stably put the whiteboard onto a support platform that is strong enough to prevent the whiteboard from falling.
- Do not place the whiteboard in a place exposed to sunlight or near heat sources.
- Store the whiteboard under allowed humidity (10%–90% (RH)) and temperature (–20 °C to +60 °C, or –4 °F to +140 °F) conditions.

## Installation Requirements



- Use the wall mount bracket with yellow labels on it. Installation and maintenance must be performed by qualified professionals.
- Do not install the whiteboard in a place exposed to sunlight or near heat sources.
- Keep the whiteboard away from dampness, dust, and soot.
- Install the whiteboard on a stable surface to prevent it from falling.
- Install the whiteboard in a well-ventilated place, and do not block its ventilation.
- The power supply must conform to the requirements of ES1 in IEC 62368-1 standard and be no higher than PS2. Please note that the power supply requirements are subject to the device label.
- The whiteboard is a class I electrical appliance. Make sure that the power supply of the whiteboard is connected to a power socket with protective earthing.
- The appliance coupler is a disconnection device. Keep it at a convenient angle when using it.

## Operation Requirements



- High voltage inside the whiteboard. Do not disassemble the whiteboard without a qualified professional present to avoid the risk of being exposed to danger.
- Improper use of the battery might result in a fire or explosion.
- Replace unwanted batteries with new batteries of the same type and model.
- Use the standard power adapter. We will assume no responsibility for any problems caused by the use of a nonstandard power adapter.
- Use the power cords that are recommended for the region and conform to the rated power specifications.
- Make sure all cables are connected correctly before plugging the whiteboard into the power. Do not overload the power socket or pull the power code. Otherwise, it might cause fire or electric shock.





- Do not drop or splash liquid onto the whiteboard, and make sure that there is no object filled with liquid on the whiteboard to prevent liquid from flowing into it.
- Operate the whiteboard within the rated range of power input and output.
- Do not disassemble the whiteboard without professional instruction.
- Use the whiteboard under allowed humidity (10%–90% (RH)) and temperature (0 °C to 40 °C, or 32 °F to 104 °F) conditions.
- The whiteboard is a class I electrical appliance. Make sure that the power supply of the whiteboard is connected to a power socket with protective earthing.
- The appliance coupler is a disconnection device. Keep it at a convenient angle when using it.

## Maintenance Requirements



- Power off the whiteboard before maintenance. Do not use the liquid cleaner or spray cleaner when cleaning the whiteboard.
- Use the clean and soft cloth or use the special lens wiping cloth when cleaning the surface of display screen. Do not use the wet cloth to clean the display screen. Otherwise, it may do harm to the screen.

# Table of Contents

Foreword.....	I
Important Safeguards and Warnings.....	III
1 Overview.....	1
1.1 Introduction.....	1
1.2 Packing List.....	1
1.3 Structure.....	2
1.3.1 Appearance.....	2
1.3.2 Dimensions.....	4
1.3.3 Ports.....	7
2 Initial Settings.....	9
2.1 Turning on the Whiteboard.....	9
2.2 Turning off Screen.....	9
2.3 Initializing the Whiteboard.....	9
2.4 Home Screen.....	12
3 Basic Operations.....	13
3.1 Quick Operations.....	13
3.1.1 Bringing up the Navigation Bar.....	13
3.1.2 Bringing up the Assistive Touch.....	13
3.1.3 Common Tools.....	14
3.2 Electronic Whiteboard.....	19
3.3 File Management.....	21
3.4 Screen Sharing.....	23
3.4.1 Sharing Screen through App.....	23
3.4.2 Sharing Screen through Wireless Presentation Dongle.....	26
3.5 Person Management.....	26
3.6 Person Sign-in.....	27
3.7 Non-contact Control.....	28
3.8 Welcome Page.....	29
3.9 Self Check.....	30
3.10 System Settings.....	30
3.10.1 Configuring Network Connection.....	30
3.10.2 Configuring General Settings.....	32
3.10.3 Configuring Advanced Parameters.....	34
3.10.4 Configuring System Parameters.....	36
4 Shutdown.....	38
5 System Update.....	39
5.1 Online Update.....	39

---

5.2 Update through USB.....	39
6 FAQ.....	40
Appendix 1 Touch Operation.....	41
Appendix 2 Cybersecurity Recommendations.....	42

# 1 Overview

## 1.1 Introduction

The smart interactive whiteboard is an integrated multimedia device, which integrates large HD screen, computer, electronic whiteboard, audio amplifier, application, and central control system.

The whiteboard supports the following functions and features:

- 4K HD LCD display.
- Switch between Android and Windows systems (for Windows, you need to install a computer module).
- One-tap projection of devices such as mobile phones and tablets.
- Electronic whiteboard.
- Various software such as Microsoft Office and audio and video players.
- Supports video conference.

## 1.2 Packing List

Check whether there is any obvious damage on the packing box. Unpack the box and check whether the components are complete according to the packing list.

Table 1-1 Packing list

Name	Quantity	Name	Quantity
Smart interactive whiteboard	1	Power cord	1
Stylus pen	2	Quick Start Guide	1
Wall mount bracket (installed on the whiteboard already)	1	Remote control	1
Legal and Regulatory Information	1	Wall-mount screw pack	1

## 1.3 Structure

### 1.3.1 Appearance

Figure 1-1 Appearance

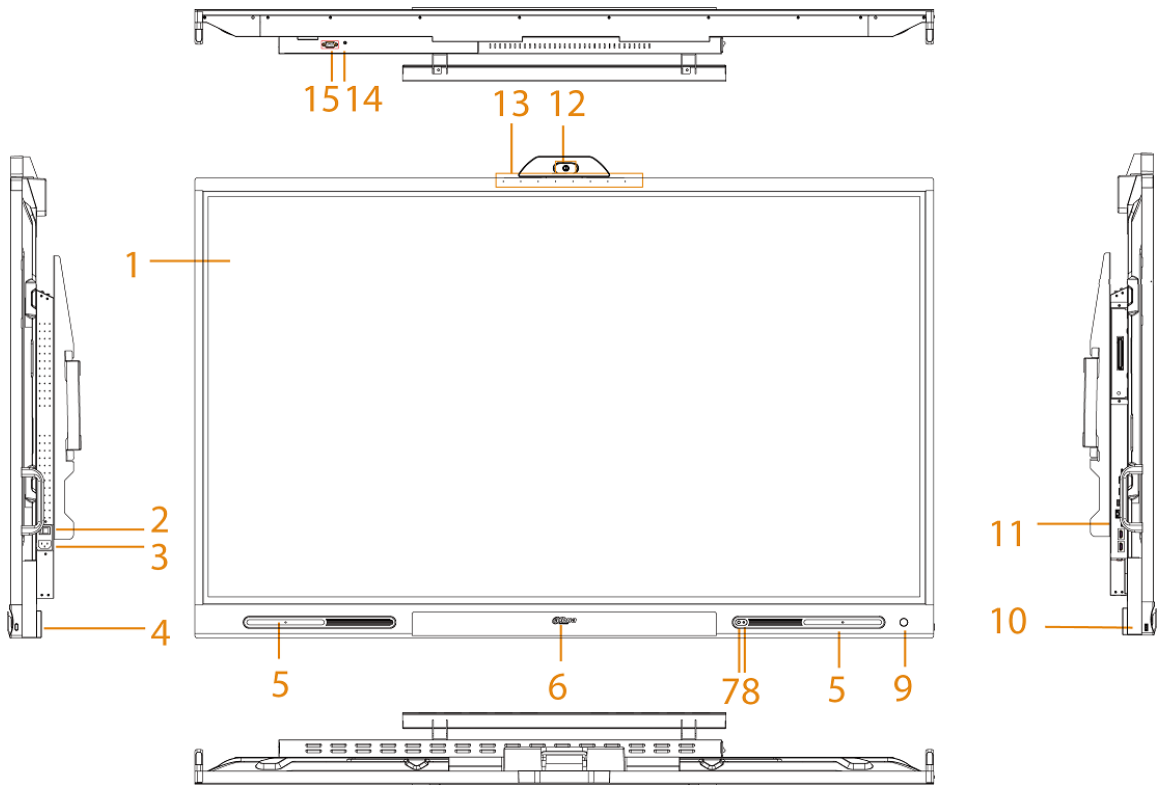



Table 1-2 Appearance description

No.	Description
1	LCD.
2	Power switch. Turn on or turn off the power supply of the whiteboard.
3	Power input port. Inputs 100–240 VAC power.  After connecting to power supply, press the power switch to turn on the whiteboard.
4	Power button. Turn on or turn off the screen.
5	Magnetic stylus pen attach area.
6	Indicator light. The light is red when the whiteboard is on standby and blue when the whiteboard is in normal use.
7	IR sensor. Receives signals from the remote control.
8	Light sensor. The whiteboard recognizes the ambient brightness through the light sensor and automatically adjusts the backlight brightness according to the ambient brightness.

No.	Description
9	Fingerprint reader. After adding your fingerprint, you can unlock the whiteboard through fingerprint recognition.
10	USB 3.0 port.
11	Side panel ports, including HDMI IN, HDMI OUT, TOUCH and other ports.
12	Built-in flip HD camera.
13	Microphones. Pick up live audio.
14	LINE OUT. An audio output port that connects to the earphone or speaker.
15	RS-232 port. Transmits data between devices. You can connect to central control devices with RS-232 port.

## 1.3.2 Dimensions

### 1.3.2.1 Dimensions (65-inch)

Figure 1-2 Dimensions (mm [inch])

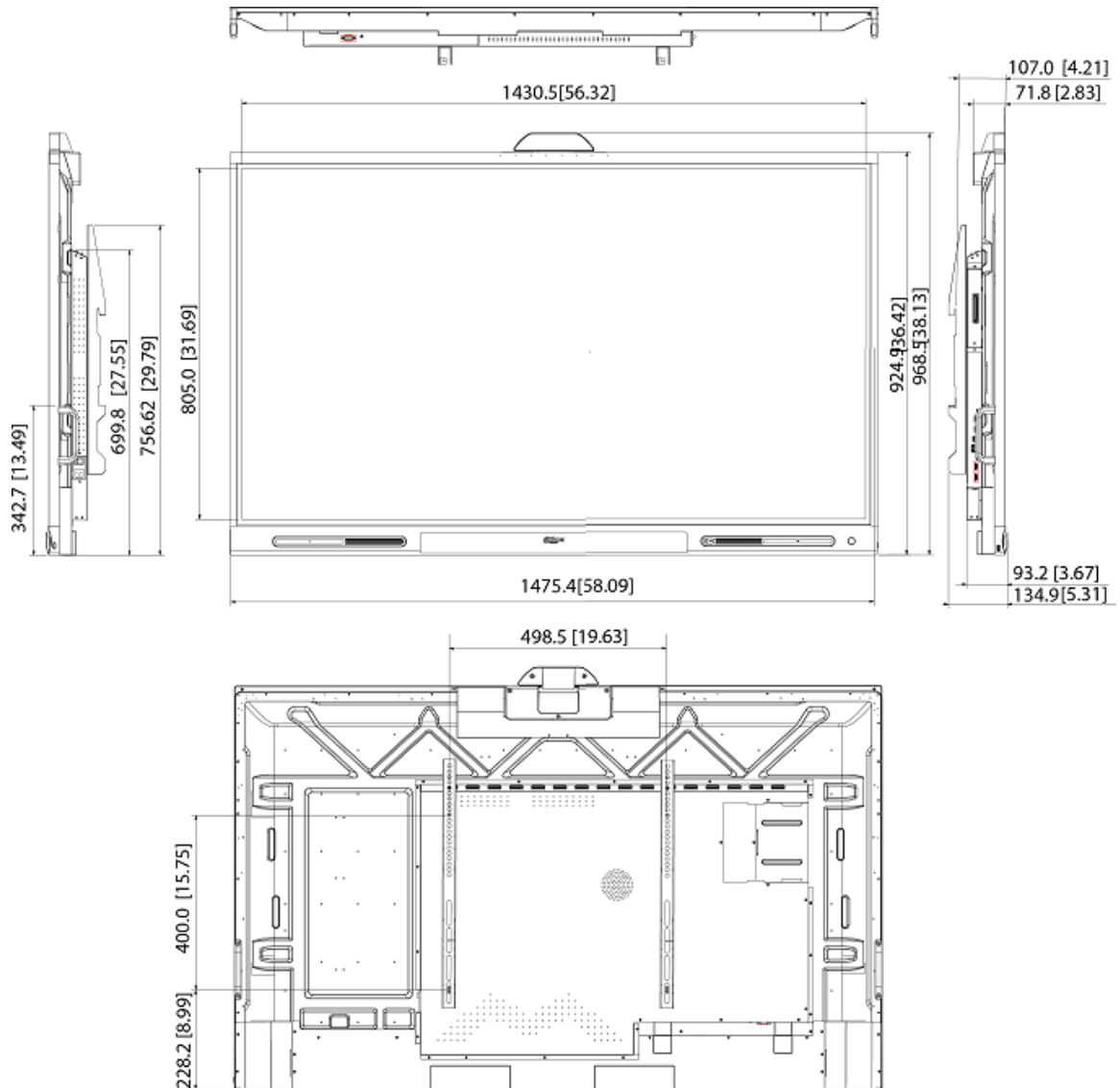

### 1.3.2.2 Dimensions (75-inch)

Figure 1-3 Dimensions (mm [inch])

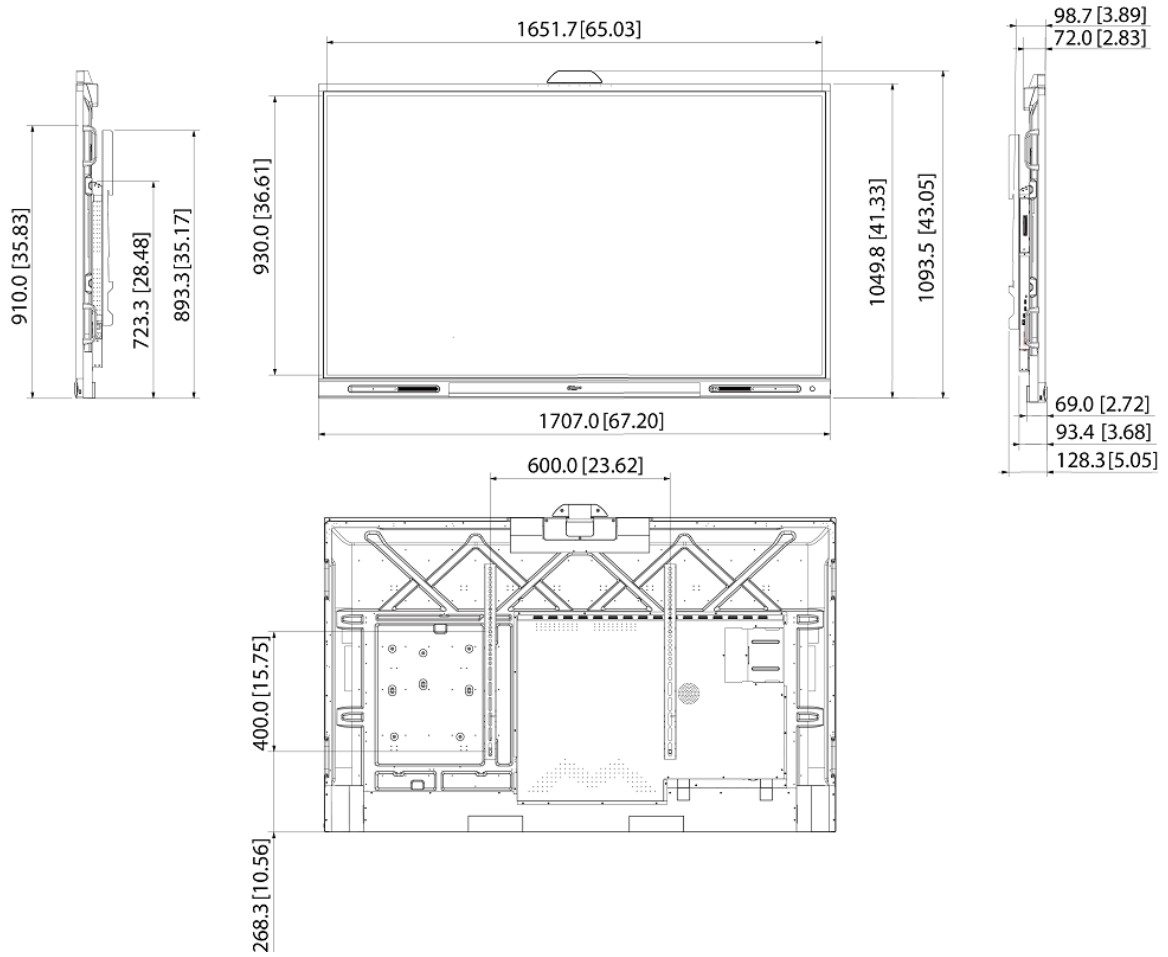



### 1.3.2.3 Dimensions (86-inch)

Figure 1-4 Dimensions (mm [inch])

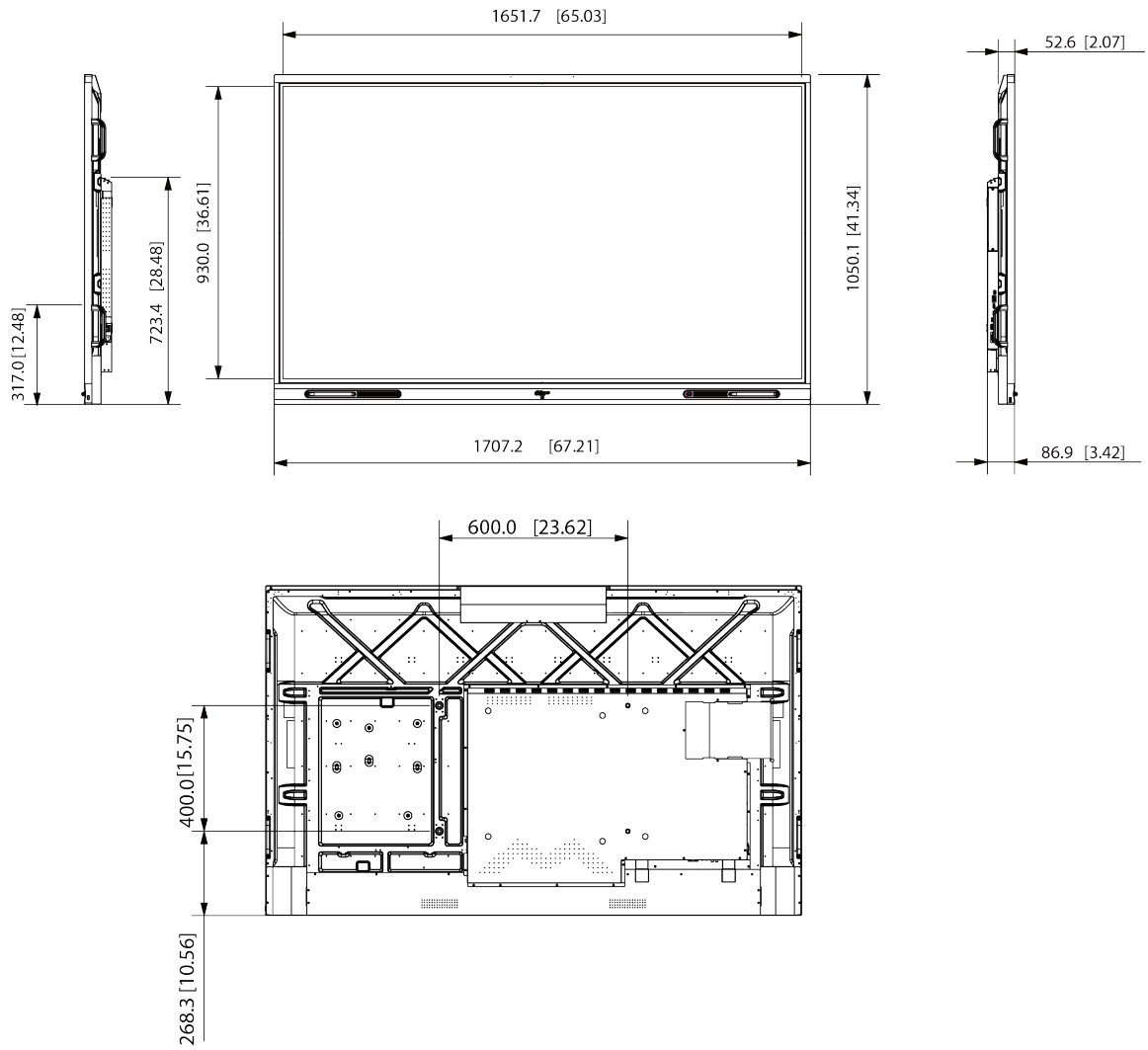

### 1.3.2.4 Dimensions (98-inch)

Figure 1-5 Dimensions (mm [inch])

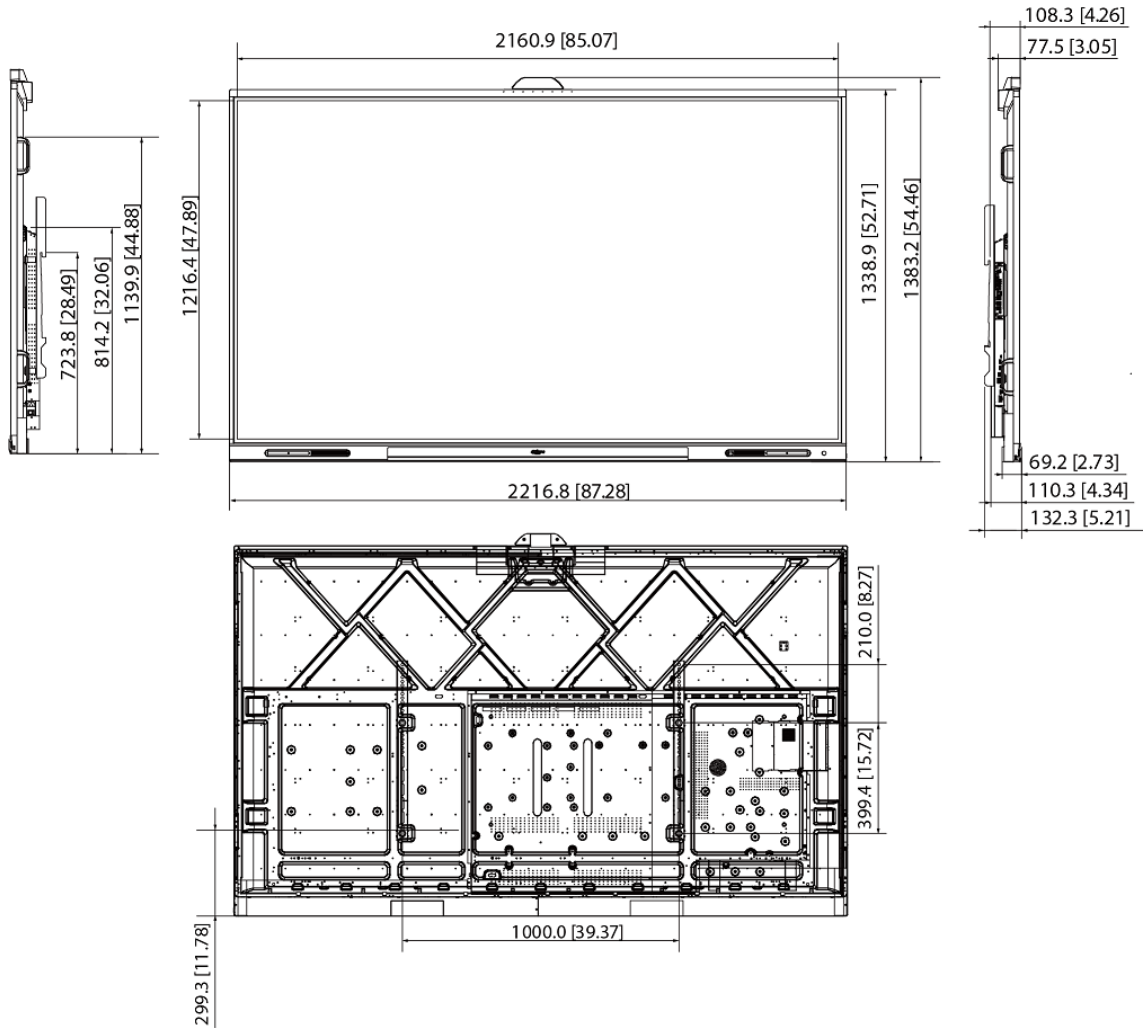

### 1.3.3 Ports

Figure 1-6 Ports

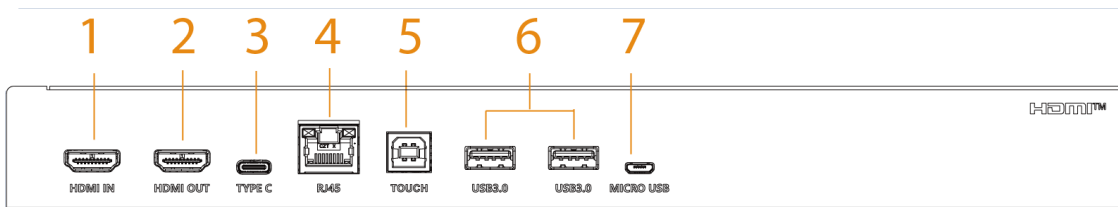

Table 1-3 Port description

No.	Name	Description
1	HDMI IN	HD audio and video signal input port. Connects to the computer, set-top box, and other video devices with HDMI output ports.

No.	Name	Description
2	HDMI OUT	HD audio and video signal output port. Transmits uncompressed HD video and multi-channel audio data.
3	TYPE C	Connect a laptop or other devices to the whiteboard through the Type C port for screen sharing and other operations.
4	RJ-45	1000 Mbps network port. Connects to network cable to access network.
5	TOUCH	Transmits touch signals. After you connect your computer with the whiteboard through HDMI port, connect the TOUCH port to the USB port of the computer, and then you can control the computer through touch operations on the whiteboard.
6	USB 3.0	Connects to USB devices such as mobile hard disk, USB flash drive, USB keyboard, and USB mouse. They are accessible both from the built-in Android system and the optional OPS computer module.
7	Micro USB	Used for debugging Android system.

## 2 Initial Settings

### 2.1 Turning on the Whiteboard

#### Prerequisites

- Before starting the whiteboard, check whether the input voltage is correct against the power supply requirements.
- To ensure the stable work of the whiteboard and the external devices connected to the whiteboard and to prolong the service life, we recommend you refer to the national related standard to use the power source that provides stable voltage with less interference from ripples.

#### Procedure

- Step 1 Connect the power cord.
- Step 2 Press the "I" end of the rocker switch next to the power cord.
- Step 3 Press the power button on the right panel to turn on the screen.

After startup, the system displays the home screen by default.

### 2.2 Turning off Screen

When the screen is on, press the power button once to turn off the screen.

After the screen has been off for 3 seconds, you can wake up the whiteboard in either of the following ways:

- Press the power button again.
- Touch the screen.



In the Windows system, if you have set a screen lock password, you need to enter the right password to wake up the whiteboard.

### 2.3 Initializing the Whiteboard

For first-time use or after restoring the system to factory settings, you need to initialize the whiteboard. After that, you can configure and operate your device.

#### Procedure

- Step 1 Power on the whiteboard.
- Step 2 Select the language, and then click **Next**.

Figure 2-1 Select the language

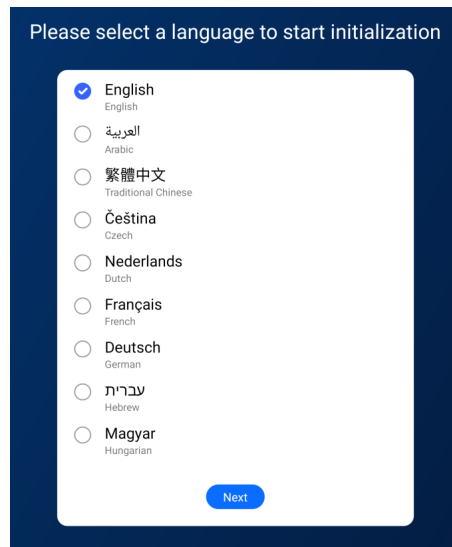

Step 3 Select the time zone, and then click **Next**.

Figure 2-2 Select the time zone

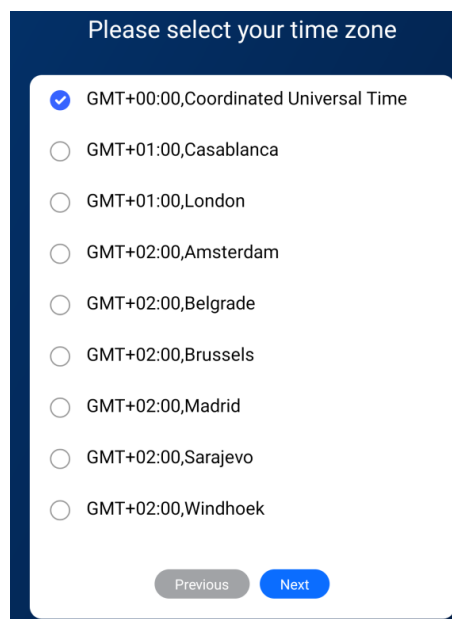

Step 4 Read the privacy policy, select **I have read and agree to all the terms**, and then click **Next**.

Step 5 Read the software license agreement, and then click **Next**.

Step 6 Set up the network, and then click **Save and Next**.

Figure 2-3 Set up the network

Field	Value
IP Assignment	<input checked="" type="radio"/> DHCP <input type="radio"/> Static
IP Address	192.168.1.101
Subnet Mask	255.255.255.0
Default Gateway	192.168.1.1
DNS1	192.168.1.1
DNS2	0.0.0.0

- DHCP: When there is a DHCP server on the network, after selecting the DHCP option, the Device automatically obtains IP address from the DHCP server.
- Static: After selecting **Static**, configure **IP Address**, **Subnet Mask**, **Default Gateway**, and then enter the IP address according to your network plan.

Step 7 Set the device name, and then click **Save and Finish**.

Figure 2-4 Set the name

Device Name: DeepHub6760



The device name must not exceed 31 characters and can only include English letters, numbers, Chinese characters, and -

## 2.4 Home Screen

Figure 2-5 Home screen



Table 2-1 Home screen description

No.	Description
1	Displays date, time and the day of the week.
2	Assistive touch. Tap the icon to quickly use functions as electronic whiteboard, annotation, and file management. See "3.1.2 Bringing up the Assistive Touch" for details.
3	Device status bar. Displays different status information. Tap each icon to view details.
4	Tap  to bring up the navigation bar. For details, see "3.1.1 Bringing up the Navigation Bar" for details.
5	Input source. Supports Windows, HDMI, and Type C.
6	<p>Function area. Tap a function icon to go to the corresponding operation screen.</p> <p></p> <ul style="list-style-type: none"> <li>For a third-party app, you can tap and hold the app to uninstall it. The apps that come with the system cannot be uninstalled in such way.</li> <li> means recommended application. You can tap it to download.</li> <li>Tap <b>Help Center</b> to view the operation guide.</li> </ul>

## 3 Basic Operations

The whiteboard can act as a computer or electronic whiteboard. This chapter introduces the basic operations of those functions. We recommend using the stylus pen to interact with the screen. For details on touch control, see "Appendix 1 Touch Operation".

### 3.1 Quick Operations

You can use the navigation bar or assistive touch to quickly use basic functions.

#### 3.1.1 Bringing up the Navigation Bar







Tap  on the left and right sides of the home screen to bring up the navigation bar.

Figure 3-1 Navigation bar



Table 3-1 Description of navigation bar

Icon	Description
	Display or hide the navigation bar.
	Go back to the previous screen.
	Go back to the home screen.
	Tap the icon to display common tools such as annotation, screen sharing, and camera. For details, see "3.1.3 Common Tools".
	Displays the apps that are running in the background. You can close the background apps one by one or in batches.

#### 3.1.2 Bringing up the Assistive Touch

Tap  on the home screen to bring up the compass menu. For details, see "3.10.2 Configuring General Settings".



Figure 3-2 Assistive touch

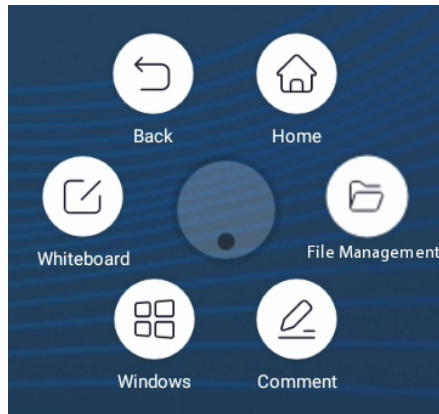

Table 3-2 Description of assistive touch

Icon	Description
	Go back to the home screen.
	Go back to the previous screen.
	Go to the electronic whiteboard screen. For details, see "3.2 Electronic Whiteboard".
	After you insert the computer module, tap the icon to switch to the Windows system.
	Turn on the annotation mode. <ul style="list-style-type: none"> <li>● Tap  to select the type of pen and the size of the brush.</li> <li>● Tap  to clear content.                             <ul style="list-style-type: none"> <li>◇ Tap  to clear unwanted content.</li> <li>◇ Tap , circle unwanted content, and then erase the selected content.</li> <li>◇ Tap  to clear all content on the screen.</li> </ul> </li> <li>● Tap <b>Save</b>, and then select the path to save your annotations.</li> <li>● Tap <b>Exit</b> to exit the annotation screen.</li> </ul>
	Manage files.

### 3.1.3 Common Tools

#### Procedure

- Step 1** Tap on the left and right sides of the home screen to bring up the navigation bar.
- Step 2** Tap to display the common tools.

Figure 3-3 Common tools

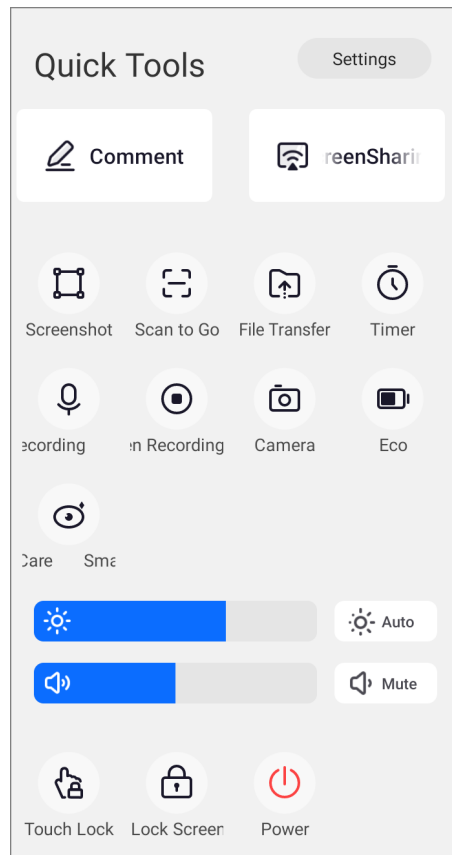











Table 3-3 Description of common tools

Section	Function	Description
Quick tools	Settings	Go to the <b>Settings</b> screen. For details, see "3.10 System Settings".
	Comment	Turn on the annotation mode. <ul style="list-style-type: none"> <li>● Tap <b>Fountain</b> to select the type of pen and the size of the brush.</li> <li>● Tap <b>Eraser</b> to clear content.                             <ul style="list-style-type: none"> <li>◇ Tap  to clear unwanted content.</li> <li>◇ Tap , circle unwanted content, and then erase the selected content.</li> <li>◇ Tap  to clear all content on the screen.</li> </ul> </li> <li>● Tap <b>Save</b>, and then select the path to save your annotations.</li> <li>● Tap <b>Exit</b> to exit the annotation screen.</li> </ul>
	Wireless Screen Sharing	Tap the icon to use the wireless screen sharing function. You can transfer content to the whiteboard through the computer or phone.

Section	Function	Description
	Screenshot	<p>Tap the icon, and then the middle area is selected by default. You can drag the four corners of the square to customize the area size.</p> <ul style="list-style-type: none"> <li>● Tap , and then you can import the screenshot to the whiteboard with one tap.</li> <li>● Tap  to capture the full screen.</li> <li>● Tap  to cancel the screenshot.</li> <li>● Tap , and then the screenshot named year - month - day - hour - minute - second.jpg will be saved to the screenshot folder.</li> </ul>
	Scan to Go	<p>Tap the icon, and then select the files that you want to share. You can select different types of files but cannot select folders. The size of a single file must not exceed 200 MB. Tap <b>OK</b> to compress 2 or more files into a zip file for transmission. After a QR code is generated, you can scan the QR code to download the file, or tap <b>Continue to Select</b> under the QR code to return to the file selection screen to select more files.</p> <p>Supports QR code. After you connect to the hotspot, use the camera app or browser on your phone to scan the code. If encryption is enabled, you need to enter the verification password after scanning the code, and the download screen will be displayed after the verification is successful.</p> <p></p> <ul style="list-style-type: none"> <li>● File sharing poses a risk of data leakage. Keep the QR code safe.</li> <li>● When the selected files have the same name, the QR code cannot be generated.</li> </ul>
	Upload to Platform	<ol style="list-style-type: none"> <li>1. After tapping the icon, tap <b>REGISTER</b> to register to the cloud management platform. Enter the server address or domain name, and then tap <b>Register</b>. You can enable or disable the cloud management platform registration (the whiteboard will be registered to the cloud management platform after the function is enabled).</li> <li>2. After registering on the cloud management platform, you can upload the files on the whiteboard to the cloud platform to be saved and managed. You can upload different types of files but cannot upload folders.</li> </ol> <p>The files are compressed into zip files. Tap <b>Upload</b>, and then the meeting list of the day and the previous two days is displayed. The default is the meeting at the upload time point meeting. If there is no meeting at this time point, the default is the nearest meeting before that time point.</p>

Section	Function	Description
	Timer	Tap the icon, and then the timer setting screen is displayed. You can start and pause the timer, set full-screen display of information on the timer, and reset the timer (reset is only available when the timer is paused, and it will reset to the initial state 00:00:00).
	Audio Recording	<p>Tap the icon to record the audio.</p> <ul style="list-style-type: none"> <li>●  : Start recording;  : Pause recording;  : Stop recording. The recorded file will be saved in .mp3 format.</li> <li>●  : Close the function.</li> </ul> <p></p> <p>The function is available only on devices with microphone.</p>
	Screen Recording	<p>Tap the icon to record the screen.</p> <ul style="list-style-type: none"> <li>●  : Start recording;  : Stop recording. The resolution is 1080P.</li> <li>●  : Start recording the audio.</li> </ul> <p></p> <p>Enable audio recording first before screen recording. Otherwise, audio recording is unable to be enabled during the screen recording.</p> <ul style="list-style-type: none"> <li>●  : Close the function.</li> </ul>
	Camera	<p>Tap the icon to take a picture.</p> <ul style="list-style-type: none"> <li>● The built-in camera supports the configuration of mirroring, white balance, WDR, exposure, and more.</li> <li>● Supports countdown settings, including: off, 3 s (default), 5 s, and 10 s.</li> <li>● Tap <b>Import Whiteboard</b>, and then you can import the screenshot to the whiteboard with one tap.</li> <li>● Tap  to save the picture to the local default folder. The picture is named year-month-day-hour-minute-second.png by default.</li> <li>● Supports scanning to go.</li> </ul>
	Eco	With this function enabled, the backlight is set to a lower value. The backlight brightness can be adjusted manually or automatically.
	Smart Eye Care	<p>Enable or disable the eye care function.</p> <p>With this function enabled, the whiteboard will reduce the intensity of its blue light and change the screen to eye care mode.</p>

Section	Function	Description
	Brightness	Drag the slider to adjust the backlight brightness. You can tap <b>AUTO</b> to enable the auto adjustment function. The whiteboard can automatically adjust the brightness according to the environment. For details, see "3.10.2 Configuring General Settings".
	Volume	Drag the slider to adjust the volume. Tap <b>MUTE</b> to enable mute.
	Touch Lock	Tap the icon to disable touch control for the screen.  Press the power button 3 times to unlock the touch control.
	Lock Screen	Tap the icon to lock the screen. Swipe the button in the middle of the screen to unlock the screen.
	Power	Tap the icon to shut down, restart the whiteboard, or exit Windows.
Update notification bar	—	<ul style="list-style-type: none"> <li>After you enable update through the cloud platform and connect the whiteboard to a WAN network, the system will pop up an update prompt window when a newer version is pushed from the platform. If you select to update later, the message that prompts you to update the system appears in the update notification bar.</li> <li>When the update package is downloaded, the system prompts you to install the package. If you select to install later, the message that prompts you to install the package appears in the update notification bar.</li> </ul>  When there is no newer version available, the update notification bar is hidden.

## 3.2 Electronic Whiteboard

Tap **Whiteboard** on the home screen to open the whiteboard software. You can write or draw pictures on the screen.

Figure 3-4 Electronic whiteboard

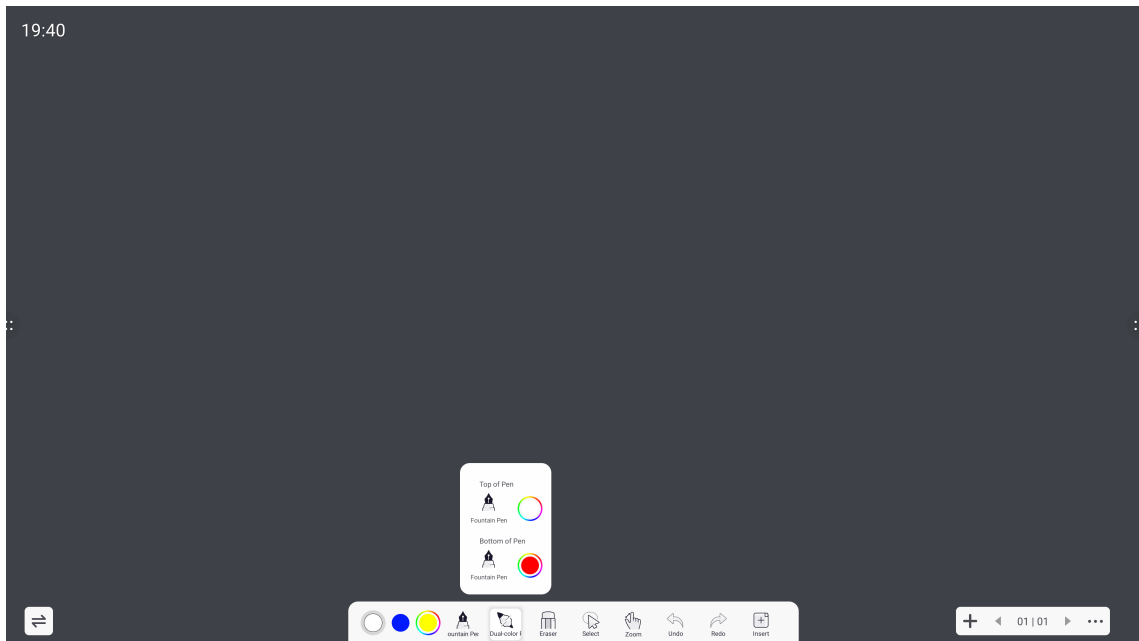











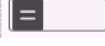







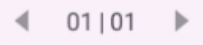







Table 3-4 Description of whiteboard icons

Icon	Description
	Adjust the location of the whiteboard tool bar.
	Select or customize the color of the pen.
Dual-color Pen	Select or customize the color of top the pen and bottom of pen.

Icon	Description
	<p>Select the type of pen and the size of the brush.</p> <ul style="list-style-type: none"> <li>  : Oily pen. By default, the color of the brush is white with 0 transparency.                     </li> <li>  : Mark pen. By default, the color of the brush is yellow with 40% transparency.                     </li> <li>  : Fountain pen. By default, the color of the brush is white with 0 transparency.                     </li> <li>  : Smart text. The handwritten content is recognized and transformed to the standard font with the color and thickness the same as the oily pen.                     </li> </ul> <p></p> <p>Smart text is only available for simplified Chinese, traditional Chinese, and English. When you write in other languages, the content cannot be recognized and transformed.</p> <ul style="list-style-type: none"> <li>  : Smart graphics. The hand-drawn graphics are recognized and transformed to standard graphics with the color and thickness the same as the oily pen. The system can recognize lines, arrows, circles, quadrilaterals, pentagrams, and more.                     </li> <li>  : Laser pen. The written content appears with a trail and disappears in 1 second. The color can be green, red, and pink.                     </li> </ul>
	<p>Erase content.</p> <ul style="list-style-type: none"> <li>Tap  to clear unwanted content.</li> <li>Tap , circle unwanted content, and then erase the selected content.</li> <li>Tap  to clear all content on the screen.</li> </ul> <p></p> <ul style="list-style-type: none"> <li>You cannot erase graphics or tables directly.</li> <li>You can press your palm on the screen and then move your hand over the words and graphics to erase them.</li> </ul>
	<p>Select content on the screen to zoom in, zoom out, move or rotate.</p>
	<p>Switch between zoom mode and co-write mode.</p> <ul style="list-style-type: none"> <li>Zoom mode: Only supports one-point writing. You can zoom in and zoom out the canvas.</li> <li>Co-write mode: Supports 10 pens writing simultaneously. You cannot zoom in or zoom out the canvas.</li> </ul>
	<p>Undo the previous action. You can undo up to 10 actions.</p>
	<p>Redo the action that has been undone. You can redo up to 10 actions.</p>

Icon	Description
	<p>Tap the icon to insert images, graphics or tables.</p> <ul style="list-style-type: none"> <li>● <b>Image:</b> You can insert images in the bmp, png, jpg, jpeg or gif format. Up to 10 images in total can be inserted.</li> <li>● <b>Graphic:</b> Select a type of graphic that you want to insert.</li> <li>● <b>Table:</b> The default table layout is 3 × 3. The table supports up to 12 columns and 12 rows.</li> </ul>
	<p>Add a whiteboard page. You can add up to 50 pages.</p>
	<p>Tap  to preview the saved file list. Tap the file to edit. When you have created several files, tap  or  to switch to the previous file and the next file. You can browse the thumbnail of the switch page.</p>
	<p>Tap the icon, and then you can perform the following operations.</p> <ul style="list-style-type: none"> <li>● <b>New</b> : Create a new whiteboard file. Remember to save your content before creating a new file, or else you will lose all your changes.</li> <li>● <b>Open</b> : Open the saved writing file. Only the whiteboard file format can be opened. After you tap <b>Open</b>, the system will jump to the whiteboard file column on file management screen.</li> <li>● <b>Change Background</b> : You can use a local background template or custom template.</li> </ul> <p></p> <p>The custom template only supports images in bmp, png, jpg and jpeg formats. The image size is limited to 5 MB. The recommended image ratio is 16:9.</p> <ul style="list-style-type: none"> <li>● <b>Save</b> : Save the file. The default name of the file is year-month-day-hour-minute-second. You can customize the file name. The file format can be wbh (source file format), pdf, and png. The source file format is used by default.</li> <li>● <b>Save as</b> : Save as a new file. The default file name is year-month-day-hour-minute-second. The file format can be wbh (source file format), pdf, and png. The source file format is used by default.</li> <li>● <b>Scan to Go</b> : Download the written whiteboard file.</li> <li>● <b>Exit</b> : Exit the whiteboard app.</li> </ul> <p></p> <p>Remember to save your modifications before exiting, or you will lose all your changes.</p>

### 3.3 File Management

Manage local files and files on the USB drive.

Tap **FileManager** on the home screen to view the whiteboard files, images, documents and more.



- Tap and hold a file or folder to select the file or folder.
- Double-tap a file or folder to open the file or folder.



Figure 3-5 File management

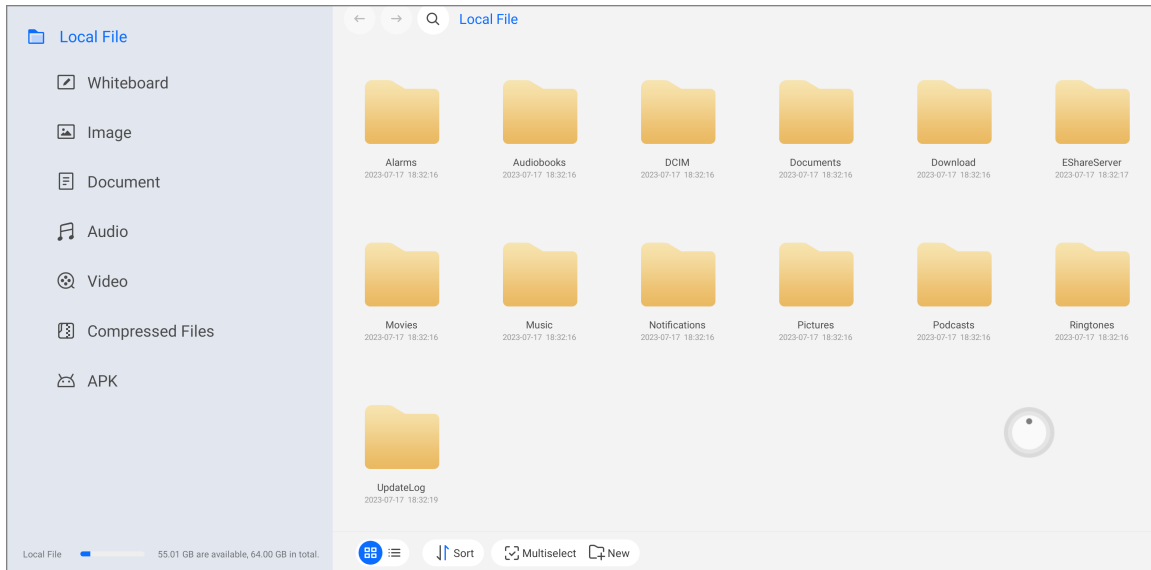

Table 3-5 File management icons

Icon	Description
	View local files on the previous or next screen.
	Enter file names to search for.
	Display files in thumbnail or list format.
Sort	Sort files in the ascending or descending order by name, size and time.
Multi-select	You can select multiple files or all the files.
New	Create a new folder.
Copy	Select a file or folder, tap <b>Copy</b> or <b>Cut</b> , and then tap <b>Paste</b> to paste the file or folder.
Cut	
Paste	
Delete	Delete files or folders.
Rename	Rename the files and folders. You cannot change the suffix of the file name.

## 3.4 Screen Sharing

You can remotely control the whiteboard on the phone, computer, or tablet, and project the content to the whiteboard screen.

### 3.4.1 Sharing Screen through App

After sharing the screen between the whiteboard and your phone or other devices such as tablets, you can project content from the phone or other devices to the screen of the whiteboard and control the whiteboard on your phone or other devices.

#### Prerequisites

The whiteboard and your computer are on the same LAN network and the hotspot of the whiteboard has been enabled. For details, see "3.10.1 Configuring Network Connection".

#### Procedure

- Step 1 Tap **Screen Sharing** on the Android home screen of the whiteboard.
- Step 2 Use your phone or tablet to scan the QR code on the lower-left corner of the screen, and then download and install the EShare app that corresponds to the operating system on your phone or other devices. For example, EShare for Android.





- You can also download the app by visiting `http://IP address:port` on your phone.
- The IP address might vary depending on the network the whiteboard is connected to.
- Tap  to zoom out the QR code.
- Tap  to enable WebCast so that you can use a browser to share the screen without the help of the EShare app.



Figure 3-6 Screen sharing



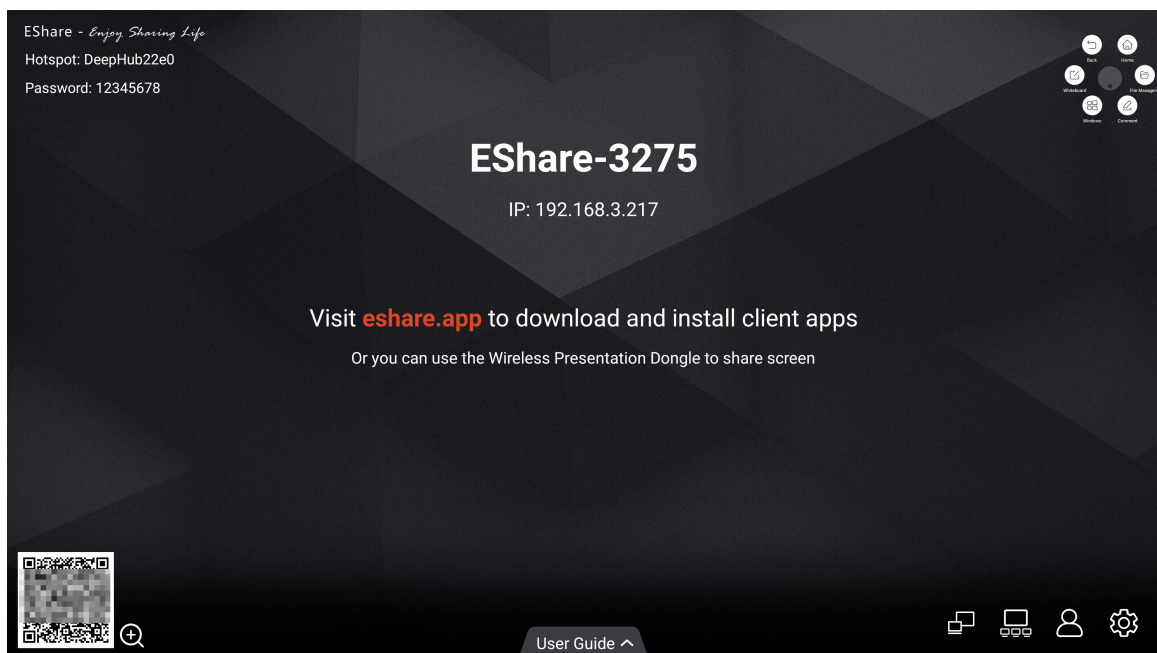

- Step 3 Open the EShare app, and then select the device name of the whiteboard to connect the whiteboard and EShare.

After connection is successful, you can control the whiteboard on your phone or other devices and project content to the whiteboard screen.

Table 3-6 EShare icon description

Icon	Description
	Enable WebCast so that you can use a browser to share the screen without the help of the EShare app.
	Group settings. <ul style="list-style-type: none"> <li>● Duplicate displays.               <ul style="list-style-type: none"> <li>◇ <b>Enable</b> : Duplicate your screen to all other devices in the display group.</li> <li>◇ <b>Only valid in client screen sharing</b> : Only when you share the screen of your phone or other devices using the client, the screen is mirrored to other devices in the group.</li> <li>◇ <b>Disable</b> : Stop duplicating your screen to the devices in the group.</li> </ul> </li> <li>● Invitation for joining display group.               <ul style="list-style-type: none"> <li>◇ <b>Auto-accept</b> : Other devices can duplicate their screen to your screen without any permissions.</li> <li>◇ <b>Notify me</b> : The system will prompt you when you receive an invitation for joining a display group.</li> <li>◇ <b>Disable</b> : Refuse to join any display groups.</li> </ul> </li> </ul>

Icon	Description
	<p>Moderator control center.</p> <ul style="list-style-type: none"> <li>● Share screen or files.                             <ul style="list-style-type: none"> <li>◇ <b>All allowed</b> : You can project the screen or send files from your phone or other devices to the whiteboard without further authorization.</li> <li>◇ <b>Need authorization</b> : The system will ask for authorization when you project the screen or send files from your phone or other devices to the whiteboard.</li> <li>◇ <b>Disable</b> : You are not allowed to project the screen or send files from your phone or other devices to the whiteboard.</li> </ul> </li> <li>● View, control and wireless annotation.                             <ul style="list-style-type: none"> <li>◇ <b>Allowed</b> : You can view and control the whiteboard screen and make annotations from your phone or other devices.</li> <li>◇ <b>View only</b> : You can view the whiteboard screen from your phone or other devices but cannot control the whiteboard or make annotations.</li> <li>◇ <b>Need authorization</b> : The system will ask for authorization to view and control the whiteboard screen and make annotations from your phone or other devices.</li> <li>◇ <b>Disable</b> : You cannot view and control the whiteboard screen and make annotations from your phone or other devices.</li> </ul> </li> <li>● Floating moderator button.                             <ul style="list-style-type: none"> <li>◇ <b>Always display</b> : The floating moderator button appears on any screen. You can tap the button to go to the moderator control center.</li> <li>◇ <b>Only on Home screen</b> : The floating moderator button appears only on the home screen.</li> <li>◇ <b>Disable</b> : Hide the floating moderator button.</li> <li>◇ <b>Auto</b> : The floating moderator appears when the whiteboard is connected to the phone or other devices. You can view the number of connected devices.</li> </ul> </li> </ul>
	<p>Display settings.</p> <ul style="list-style-type: none"> <li>● <b>Device Name</b> : You can customize the device name.</li> <li>● <b>Connection Mode</b> : Select a connection mode.                             <ul style="list-style-type: none"> <li>◇ Device name: When you open EShare, the app will automatically display large display devices on the same network. Select the device name of the whiteboard to connect the whiteboard and EShare.</li> <li>◇ PIN code (4 digits): You need to enter the 4-digit PIN code to connect the whiteboard and EShare.</li> <li>◇ PIN code (6 characters): You need to enter the 6-character PIN code to connect the whiteboard and EShare.</li> </ul> </li> <li>● <b>Multiple Screens</b> : Select <b>Disable</b>, <b>2 Screens</b>, <b>4 Screens</b>, <b>6 Screens</b>, or <b>9 Screens</b>.</li> <li>● <b>Show Device Name on Screen</b> : Show the name of the devices connected with the whiteboard.</li> <li>● <b>Auto Fullscreen</b> : The screen of the connected device covers the full screen of the whiteboard even though the screen aspect ratios of the whiteboard and the connected device are different.</li> <li>● <b>AirPlay Visible</b> : Allow iOS and macOS devices on the same network with the whiteboard to share screen without installing the EShare app.</li> </ul>

Icon	Description
User's Manual	View the basic guide of screen sharing.

### 3.4.2 Sharing Screen through Wireless Presentation Dongle

After sharing the screen between the computer and whiteboard, you can project content from the computer to the screen of the whiteboard and control the whiteboard on your computer.

#### Prerequisites

- The whiteboard and your computer are on the same LAN network and the hotspot of the whiteboard has been enabled. For details, see "3.10.1 Configuring Network Connection".
- Get a compatible wireless presentation dongle. It does not come with the whiteboard. Purchase it as needed.

#### Procedure

Step 1 Pair the wireless presentation dongle with the whiteboard.

1. Tap **Screen Sharing** on the Android home screen of the whiteboard.
2. Insert the wireless presentation dongle into the USB port on the front panel of the whiteboard.

The wireless presentation dongle starts pairing with the whiteboard.

3. Wait until the system prompts successful pairing.
4. Tap **OK**.

Step 2 Project content from your computer to the whiteboard.

1. Connect the wireless presentation dongle to the USB port of your computer.



For the first-time use, you might need to install the driver of the wireless presentation dongle. The installation might take a while. If installation failed, download the driver manually and then try again.

2. Press the button on the wireless presentation dongle to project content from your computer to the whiteboard.

## 3.5 Person Management

Register person information for meeting sign-in.

#### Prerequisites

- Make sure that you have enabled **Target Recognition**. For details, see "3.10.3 Configuring Advanced Parameters".
- Make sure that you have configured the digital password or unlock pattern.

#### Procedure

Step 1 Select **More > Person Management** on the home screen of the Android system.

Step 2 Enter the password.

Step 3 Tap **Add Person**.

Step 4 Make sure that the person is located in the recognition frame. When the system will recognize the person and then automatically take a snapshot.



If 2 or more persons appear in the recognition frame, you need to register the person information again.

**Step 5** Enter the name and No. of the person, and then tap **Save**.

Figure 3-7 Person management

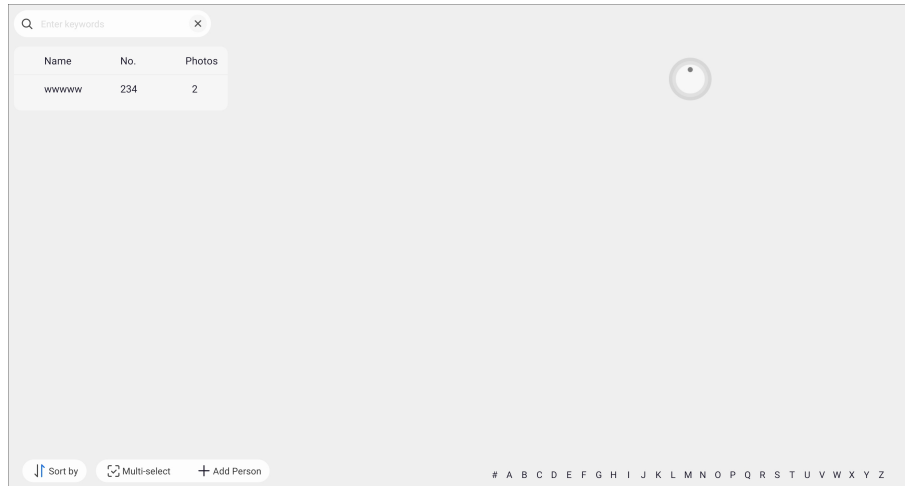

### Related Operations

- Sort: Sort the persons by name in the alphabetic order or by No. in the ascending order.
- Multi-select: Select one or more persons and then delete them in batches.
- Add person: Add more persons. You can register up to 20,000 persons.
- Modify: Tap a person record, and then you can modify the information on the person, such as editing the name and adding corresponding photos.

## 3.6 Person Sign-in

### Prerequisites

- Make sure that the camera works well.
- Make sure that you have enabled **Target Recognition**. For details, see "3.10.3 Configuring Advanced Parameters".
- Make sure that you have registered the persons that attend the meeting. For details, see "3.5 Person Management".

### Procedure

- Step 1** Select **More > Sign in** on the home screen of the Android system.
- Step 2** Tap **Sign in**. The whiteboard recognizes persons whose information has been added to its database and registers their attendance.
- Step 3** When the whiteboard detects a person whose information is not found in the database, the person appears on the **Unregistered** list. Tap **Add Participant** to add the person to the temporary person database.



The temporary person database will be deleted automatically after you end the sign-in process.

**Step 4** Tap **End Sign-in Process**. The system generates a sign-in list that supports scan to go.

Figure 3-8 Sign-in

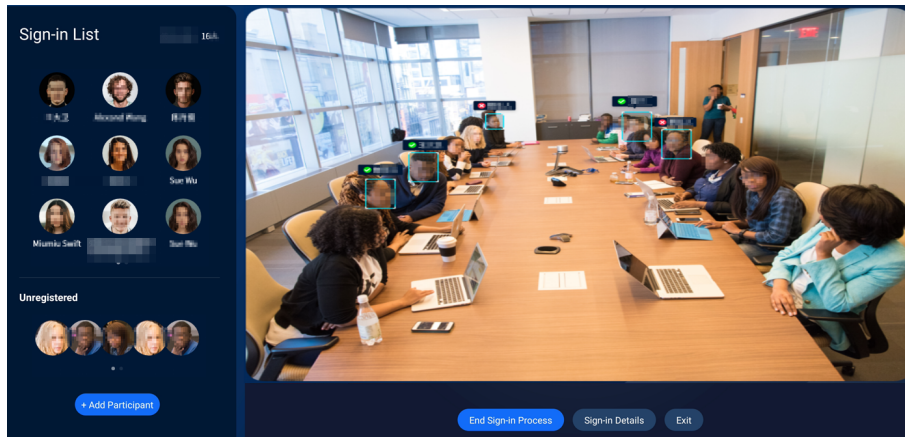

### 3.7 Non-contact Control

You can use non-contact gestures to swipe screens or take snapshots.

#### Prerequisites

- Make sure that you have enabled **Non-contact Control**. For details, see "3.10.3 Configuring Advanced Parameters".
- The camera that comes with the whiteboard works well.

#### Procedure



Step 1 Keep waving hands for 3 to 5 seconds.  appears on the screen for 1 s, meaning the whiteboard enters non-contact control mode.

In non-contact control mode, the camera keeps track of your gestures. If no gesture is detected within 10 minutes, the whiteboard automatically exits non-contact control mode. You need to turn on the mode again.



- We recommend you perform gestures 1 to 3 m away from the screen.
- Make sure to look directly at the camera with nobody standing between you and the whiteboard or closely behind you.
- If your face leaves the view range of the camera or is blocked, the camera cannot find the target and the whiteboard automatically exits non-contact control mode.

Step 2 Use your gestures to control the screen.

- Turn the screen left: Make a fist with one hand with the thumb pointing to the left (a gesture like ) , place the hand in front of your right shoulder, and then slowly move your hand to the left for 1 to 2 seconds.
- Turn the screen right: Make a fist with one hand with the thumb pointing to the right (a gesture like ) , place the hand in front of your left shoulder, and then slowly move your hand to the right for 1 to 2 seconds.
- Take a screenshot: Make a V-sign (a gesture like ) , place the hand in front of you at the head height, and then slowly move your hand downward for 1 to 2 seconds.

The whiteboard takes a full screenshot by default. After the screenshot, you can view the storage path on the upper-right corner of the page.

### 3.8 Welcome Page

#### Prerequisites

Import the media such as images and audio files used to create the welcome page.

#### Procedure

- Step 1 Select **More** > **Welcome Page** on the home screen of the Android system.
- Step 2 Tap **Setting** on the lower-right corner to configure the welcome page.

Figure 3-9 Configure the welcome page

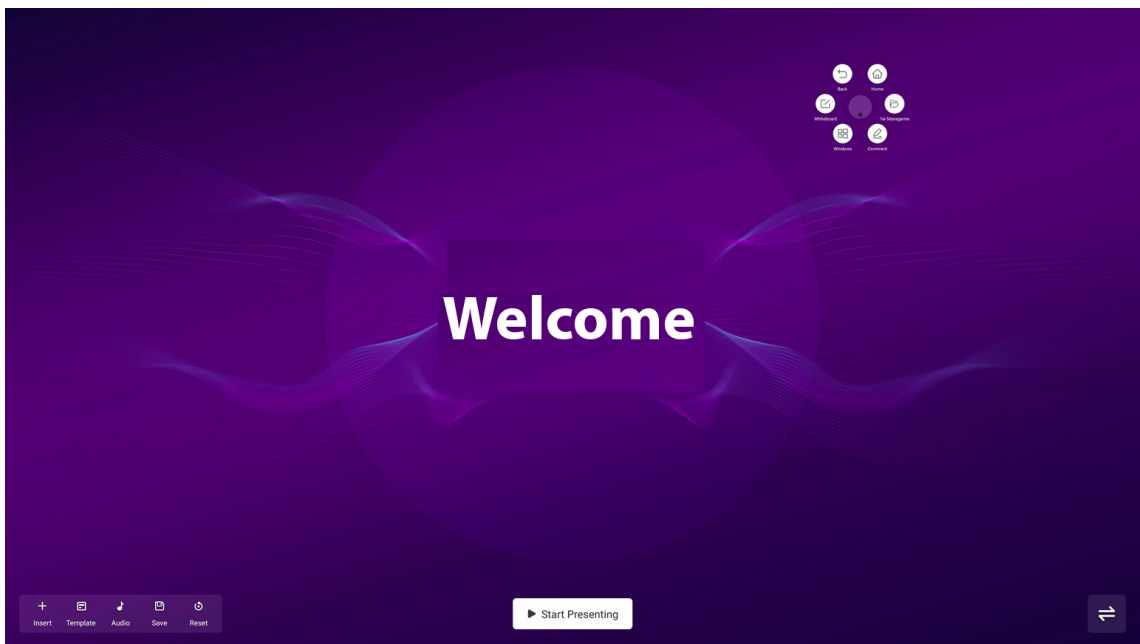

Table 3-7 Icon description

Icon	Description
	Change the position of the toolbar.
Insert	Insert a background image or other images and text.
Template	You can use local background template or custom template.
Audio	Insert audio.
Save	Save your configurations.
Restart	Restore the welcome page to the default template.
Start Presenting	Show the presentation effect of the welcome page.

- Step 3 Tap **Save**. You can swipe left on the home screen to view the welcome page.



## 3.9 Self Check

Select **More** > **Self Check** on the home screen of the Android system, tap **Scan**, and then wait for a while. The system shows the results.

Figure 3-10 Self check result

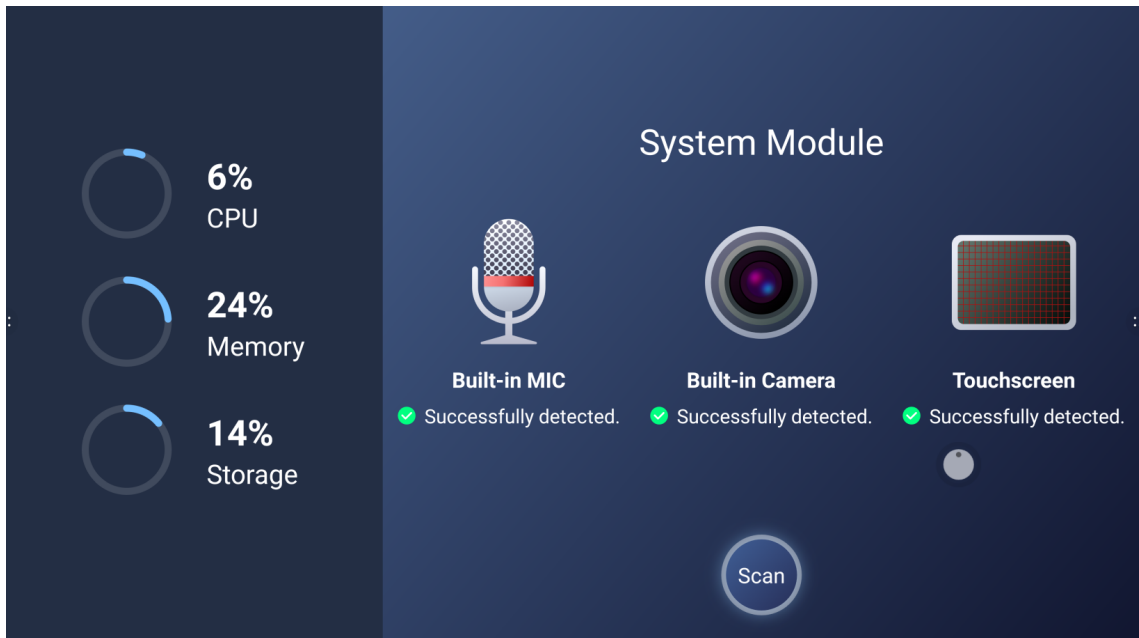

## 3.10 System Settings

Configure network settings, general and advanced settings, and other system settings.

### 3.10.1 Configuring Network Connection

On the home screen, tap **More** > **Settings** to configure the network settings.



You can enable wireless network or wired network. Wireless network and wired network cannot be enabled at the same time. The whiteboard itself can also act as a hotspot to share network connection with other devices.

Figure 3-11 Network

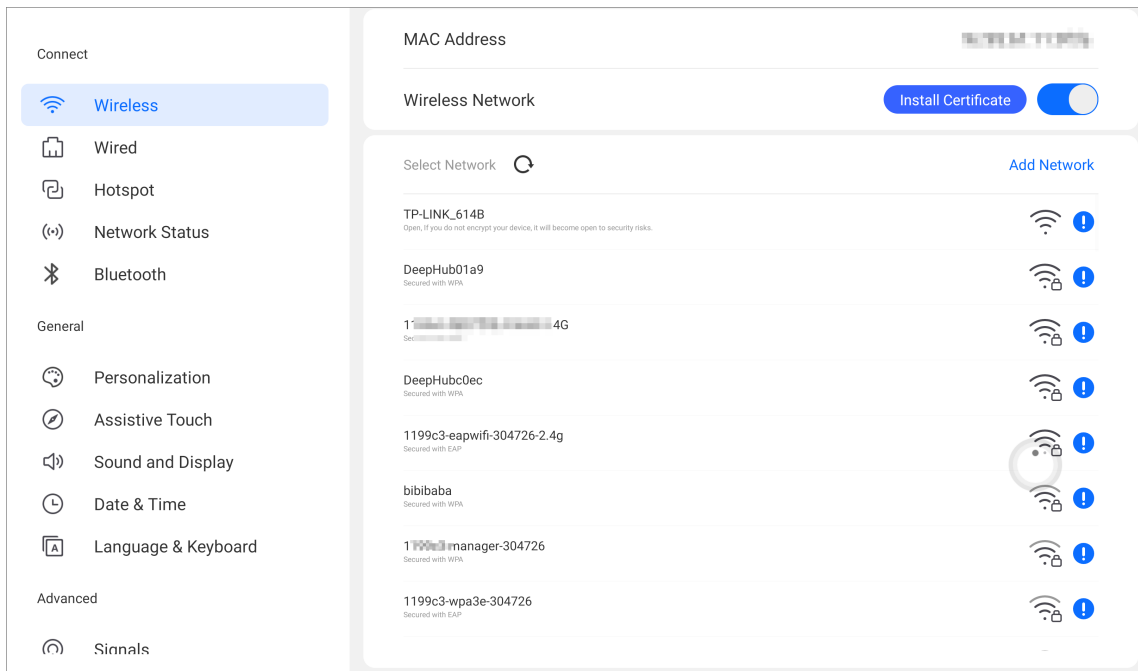



Table 3-8 Network parameters

Parameter	Description
Wireless	<p>Enable <b>Wireless Network</b>, and then the whiteboard can connect to an available Wi-Fi network in the area. To add a wireless network, tap <b>Add Network</b>, enter the SSID network name and password, and then configure advanced settings as needed.</p> <p></p> <ul style="list-style-type: none"> <li>• Supports installing certificate.</li> <li>• We recommend you select a secure authentication method to connect to a wireless network.</li> </ul>
Wired	<p>Configure wired network connection parameters.</p> <ul style="list-style-type: none"> <li>• <b>DHCP</b>: When there is a DHCP server on the network, you can enable <b>Wired</b>, and then the whiteboard gets a dynamic IP address automatically.</li> <li>• <b>Static</b>: Set IP address, subnet mask, default gateway and DNS manually for the whiteboard.</li> </ul>
Hotspot	<p>Enable <b>Hotspot</b>, configure the network SSID and then enter the password. You can view hotspot name, hotspot password, encryption method, frequency band and other information.</p>
Network Status	<p>Displays information such as the current network connection mode, IP address, default gateway, subnet mask, and DNS.</p>

Parameter	Description
Bluetooth	<p>Enable <b>Bluetooth</b>, and then the whiteboard displays the Bluetooth name, paired devices and other devices.</p> <p>The whiteboard can play audio by speaker through Bluetooth connection.</p>  <p>If you need to use a Bluetooth microphone, wireless Bluetooth mouse or keyboard, please insert the USB dongle first.</p>

### 3.10.2 Configuring General Settings

On the home screen, tap **More** > **Settings** to configure the general settings.

Figure 3-12 General settings

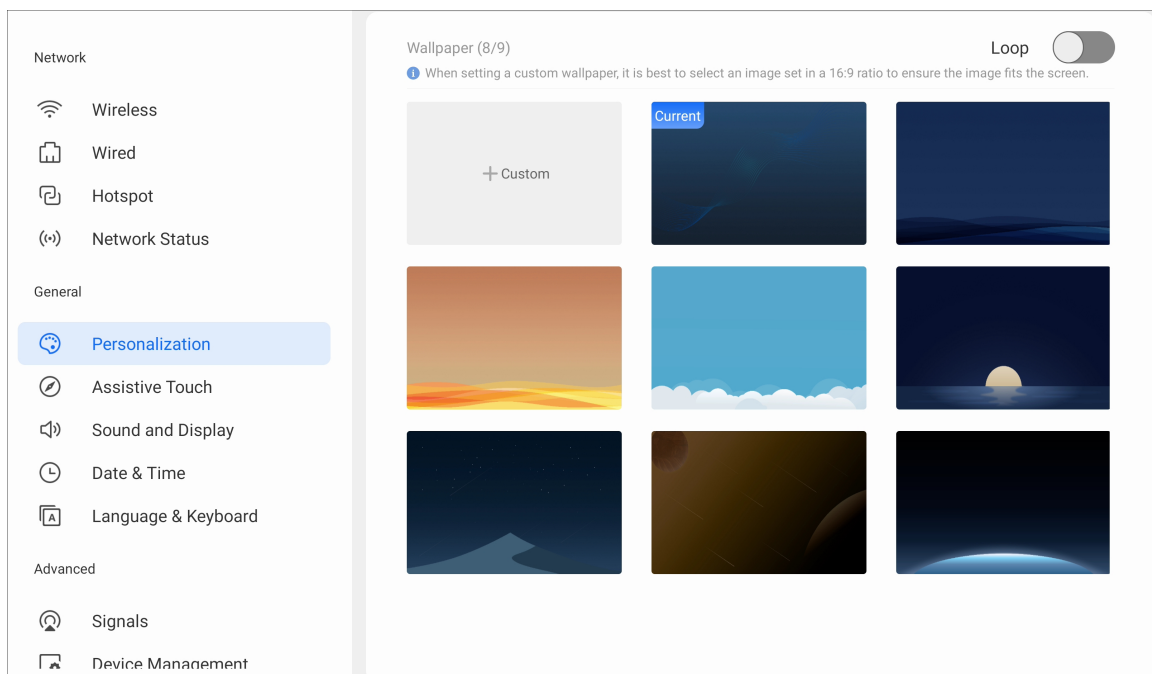



Table 3-9 General settings description

Parameter	Description
Personalization	<p>Set the background image, and you can enable Loop to play the selected background images in turn and customize the boot screen.</p> <ul style="list-style-type: none"> <li>• The system provides 8 wallpapers by default.</li> <li>• You can also customize and upload wallpapers. The recommended image ratio is 16:9.</li> </ul>

Parameter	Description
Assistive Touch	<p>Enable for disable the assistive touch. Select or customize when the assistive touch is automatically hidden away, and the manner in which it is hidden (small circle or disappear).</p>  <p>After you enable the assistive touch, double-tap with 3 fingers in 2 seconds to bring it up.</p>
Sound and Display	<ul style="list-style-type: none"> <li>● Adjust the level of volume. If the volume is 0, a mute sign will be displayed at the lower-left corner of the screen.</li> <li>● Sound effect: You can select <b>Standard</b> , <b>Music</b>, <b>Meeting</b> and <b>Theater</b>.</li> <li>● System sound prompt: You can use the default audio or external audio. You can add up to 10 external audio files with each file smaller than 500 KB.</li> <li>● Brightness can be adjusted manually in the range of 1–100 or automatically according to the ambient brightness.</li> <li>● Indicators: You can select <b>Breathing Light</b> , <b>Marquee Light</b>, or <b>Always</b> depending on how you want the indicator light to indicate the running or update status. The indicator light is solid blue by default.</li> </ul>
Date & Time	<p>Set the date and time automatically or manually. You can configure the format of the time, date and time zone.</p> <p>With <b>Auto Sync Time</b> enabled, the system time is synchronized with the server time. When it is disabled, you need to manually set the date and time.</p>
Language & Keyboard	<p>Select the system language and the input method.</p>

### 3.10.3 Configuring Advanced Parameters

On the home screen, tap **More** > **Settings** to configure the advanced parameters.

Figure 3-13 Advanced parameters

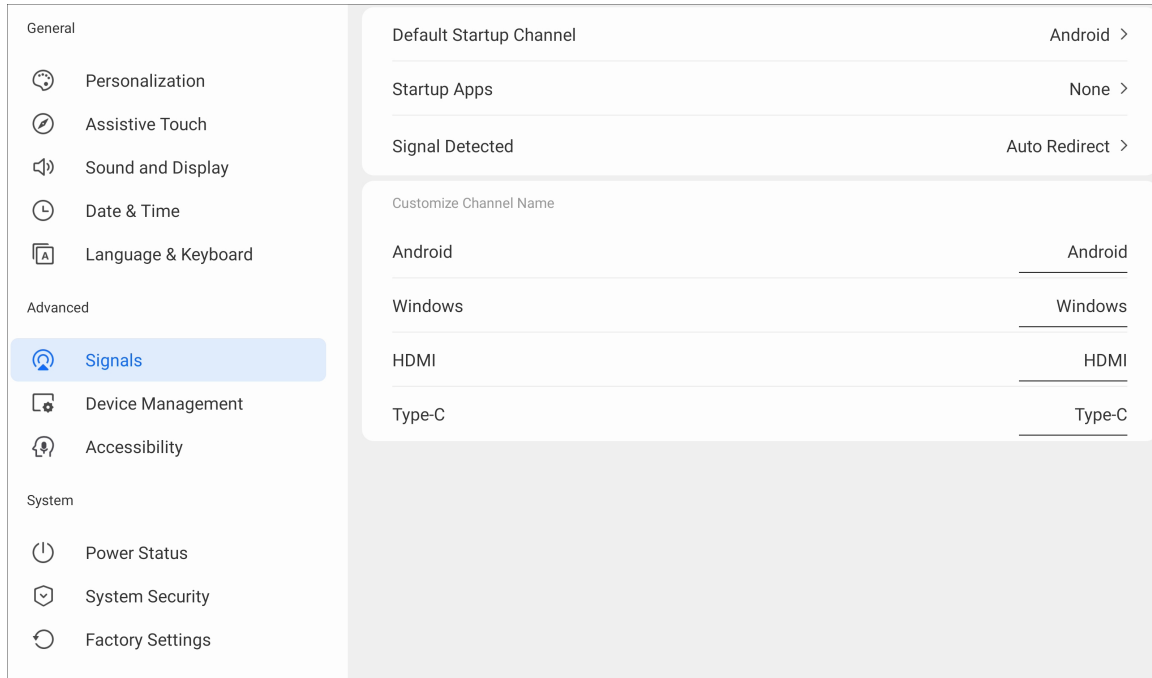



Table 3-10 Description of advanced parameters

Parameter	Description
Signals	<ul style="list-style-type: none"> <li>● <b>Default Startup Channel:</b> Select the channel to be enabled at startup.</li> <li>● <b>Default Apps:</b> Select an application that is on the whiteboard to be opened every time the system starts.</li> <li>● <b>Signal Detected:</b> <ul style="list-style-type: none"> <li>◇ <b>Auto Redirect :</b> Connect to the signal source and automatically redirect to the corresponding channel.</li> <li>◇ <b>Pop-up Window :</b> When a signal source is connected, a pop-up window appears asking whether to jump to the connected source channel.</li> </ul> </li> <li>● <b>Customize Channel Name :</b> Customize the channel name. After the name is modified, the corresponding channel name of the whole system will be modified synchronously.</li> </ul>

Parameter	Description
Device Management	<ul style="list-style-type: none"> <li>● View information on the camera, microphone, and speaker. You can import firmware package to update the camera or recalibrate the postilion of the camera.</li> <li>● <b>HDMI OUT</b> : The function is available after the whiteboard is connected to a monitor through the HDMI OUT port. After you enable <b>HDMI OUT</b>, the whiteboard outputs signals at the maximum resolution of the monitor by default. You can select different resolutions depending on the capacity of the monitor.</li> <li>● <b>Pick-up Pen Detection</b> : After you enable the function, when you pick up a stylus pen from the pen attaching area at the bottom of the whiteboard, the system pops up a window and prompts you to open electronic whiteboard or enter annotation mode.                        The system does no give pick-up pen prompt during the setup wizard and update.</li> <li>● <b>RS-232 Control</b> : With <b>RS-232 Control</b> enabled, you can connect the whiteboard to the RS-232 transparent debugging serial port for data transmission between devices.</li> <li>● <b>IR Frame Version</b> : Tap <b>Update</b> to update the version of the IR frame.</li> <li>● <b>SCM Version</b> : Tap <b>Update</b> to update the version of the SCM (Single-Chip Microcomputer).</li> </ul>
Accessibility	<ul style="list-style-type: none"> <li>● <b>Non-contact Control</b> : Use gestures to turn screens and take screenshots.</li> <li>● <b>Target Recognition</b> : Recognizes target.                         <ul style="list-style-type: none"> <li>◇ <b>Person Unlock</b> : Applies to screen lock and touch lock.                                  After you enable the function, a registered person can unlock the whiteboard and an unregistered person can wake up the screen.</li> <li>◇ <b>Speaker Tracking</b> : Applies to video conference.   <ul style="list-style-type: none"> <li>○ Audio tracking: The whiteboard tracks the participant who is speaking, places the speaker in the middle of the image and adjusts the image size through digital zoom.</li> <li>○ Auto-farming: The camera supports self-adaptive panoramic shooting. It can adjust the image to include all participants according to the number of participants and their positions. The participants are located in the middle of the image with the size of the nameplates of the participants in the panoramic image automatically adjusted.</li> </ul> </li> </ul> </li> </ul>  Non-contact control and target recognition cannot be enabled at the same time.

### 3.10.4 Configuring System Parameters

On the home screen, tap **More** > **Settings** to configure the system parameters.

Figure 3-14 System parameters

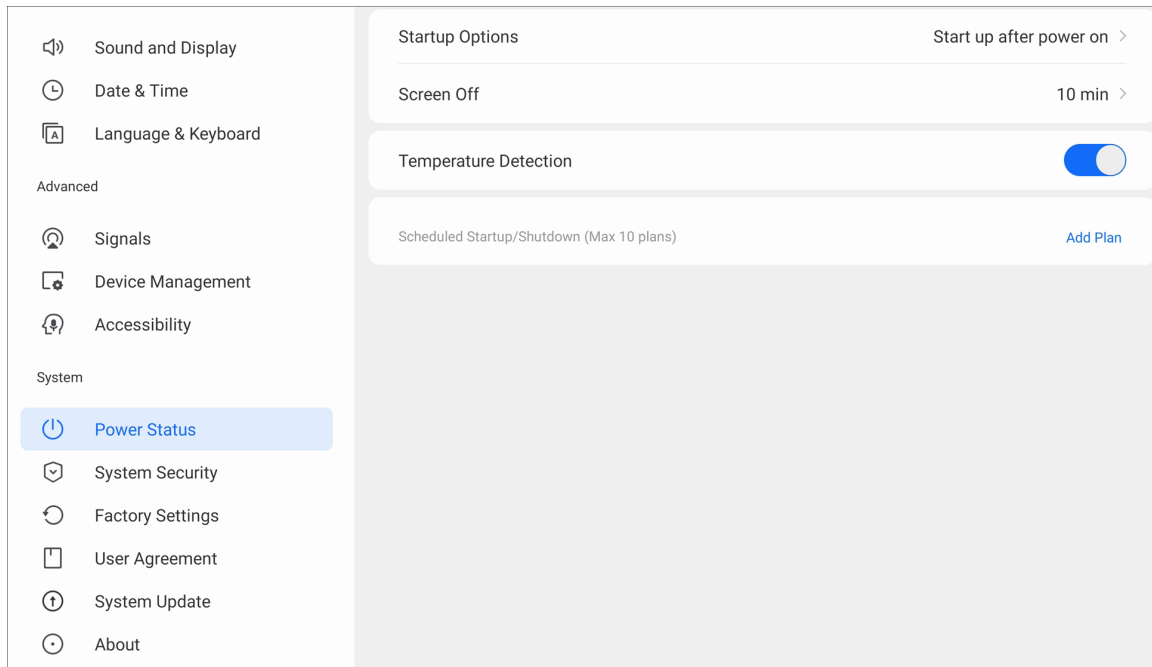





Table 3-11 System parameter description

Parameter	Description
Power Status	<p>Set the startup and shutdown functions of the whiteboard.</p> <ul style="list-style-type: none"> <li>● <b>Startup Options</b> : Select standby after power on or startup after power on (default).</li> <li>● <b>Screen Off</b> : Offers always on and no operation after 1 min, 5 min and 10 min. It also has custom configuration from 1 to 60 min.</li> <li>● <b>Temperature Detection</b> : After you enable the function,  appears on the upper-right corner of the home screen. When the temperature of CPU is higher than 80 °C, the icon becomes orange. When the CPU temperature is higher than 90 °C, the icon becomes red.</li> <li>● <b>Scheduled Startup/Shutdown (Max. 10 plans)</b> : Tap <b>Add Plan</b> to set when to automatically power on and off the system. Tap  to delete the plan.</li> </ul>

Parameter	Description
System Security	<ul style="list-style-type: none"> <li>● <b>Pin</b> : After enabling <b>Pin</b>, you can unlock the whiteboard with digital password.</li> <li>● <b>Unlock Pattern</b> : After enabling <b>Unlock Pattern</b>, you can unlock the whiteboard by drawing a pattern.</li> <li>● <b>Password Reset Email</b> : Set the password reset email. You can use the email to reset the device password.</li> <li>● <b>Fingerprint</b> : After enabling <b>Fingerprint</b>, you can unlock the whiteboard with your registered fingerprint.</li> <li>● <b>Lock Screen</b> : Tap <b>Lock screen</b>, and then select a screen lock option, including no operation after 1 min, 5 min and 10 min, and custom configuration.</li> <li>● <b>Touch Lock</b> : After enabling touch lock, you cannot use touch control on the screen. Press the power button 3 times in 2 seconds to unlock the touch lock.</li> <li>● <b>USB Permission</b> : With USB permissions disabled, the system does not detect the access of USB devices.</li> </ul>  <ul style="list-style-type: none"> <li>● The system does not support the simultaneous use of pattern password and digital password.</li> <li>● Press the power button for 3 times in 2 seconds or use the password to unlock the whiteboard.</li> </ul>
Factory Settings	Tap <b>FACTORY SETTINGS</b> , and all your operation records and saved content will be deleted. The whiteboard will also be restored to its factory settings.
User Agreement	View the privacy policy, software license agreement, and open source agreement.
System Update	View the current system version. When the whiteboard is connected to a network, tap <b>CHECK FOR UPDATES</b> to check whether there is a new version available.
About	View MAC address, device serial number, device name (can be edited), running memory, storage space, resolution, system version, Android version, and security baseline version.  <p>The device name can consist of up to 31 characters and contain letters, numbers, and special characters (-@.).</p>



## 4 Shutdown

After the whiteboard is turned on, press and hold the power button for 5 s, and then the system will prompt you whether to shut down the whiteboard. Tap **OK** to shut down the whiteboard.

## 5 System Update

You can update the system online or through USB.



Please be advised that downgrading to a lower version will make the whiteboard vulnerable to security attacks.

### 5.1 Online Update

After the whiteboard is registered to the cloud management platform, the platform can send the update package to the whiteboard.

#### Prerequisites

- Make sure that the whiteboard is connected to the network.
- Make sure that you have enabled OTA platform in **More > Settings > System Update**.

#### Procedure

- Step 1 On the home screen, select **More > Settings > System Upgrade**.
- Step 2 Tap **CHECK FOR UPDATES**.
- Step 3 When the system detects that a newer version available, tap **Download** to download the update package.
- Step 4 After the package is downloaded, you can select to install the package immediately. After it updates, the whiteboard restarts automatically.

### 5.2 Update through USB

You can upload update.zip file into a USB flash drive and then use the update file to update the system.

#### Prerequisites

Get the update package from the technical support.

#### Procedure

- Step 1 Change the name of the update package to update.zip, and then save the file to the root directory of the USB flash drive.
- Step 2 With whiteboard turned on, plug the USB flash drive into the USB port of the whiteboard.



Update the system with a USB flash drive in the FAT 32 format. Otherwise, update might fail.

- Step 3 When the system prompts whether to update immediately, tap **Upgrade**. The update begins. After it updates, the whiteboard restarts automatically.

## 6 FAQ

1. **The indicator light is off.**

- Check whether the power supply is normal.
- Check whether the rocker switch of the whiteboard is turned on.

2. **Missing or abnormal colors.**

If the whiteboard is connected to a computer, check whether the HDMI cable is intact and correctly connected.

3. **The image is not displayed in full screen or part of the image is outside the screen.**

- Check whether the resolution is 16:9.
- If the whiteboard is connected to an external computer, unplug the HDMI cable and then plug it back in.

4. **The whiteboard displays images but has no sound.**

- Adjust the volume.
- If the whiteboard is connected to a computer, check whether the audio cable is correctly connected.

5. **Touch response is poor and the location that responds is not accurate.**

- Check whether other objects such as paper or your sleeves are in contact with the screen.
- Check whether the resolution is 16:9.

6. **Touch control is not working.**

If the whiteboard is connected to a computer, check whether the TOUCH port of the whiteboard is correctly connected to the USB port of the computer.

# Appendix 1 Touch Operation

You can use the stylus pen or directly use your fingers to operate the device screen.



This section uses operation with stylus pen as an example.

Appendix Table 1-1 Touch operations

Operation	Description
Tap	Tap the screen once with the stylus pen.
Double-tap	Tap the screen twice with the stylus pen (The time gap between the taps is around 0.5 s).
Context menu	Slightly touch the screen for 1 to 2 seconds with the stylus pen. Lift the stylus pen when there is a circle on the screen, and then the context menu is displayed.
Drag	Hold the icon that needs to be dragged with the stylus pen and then move the stylus pen to the target place. Lift the stylus pen to drop the item.
Slide	Hold the screen (such as the slider that is used for the web browser) that you want to slide with the stylus pen, and then slide the stylus pen toward the direction you want. Lift the stylus pen to release the screen.
Zoom	Use the stylus pen to press and hold the window (such as the web pages and images), and then use another stylus pen to drag the window to zoom in and zoom out.

## Appendix 2 Cybersecurity Recommendations

Cybersecurity is more than just a buzzword: it's something that pertains to every device that is connected to the internet. IP video surveillance is not immune to cyber risks, but taking basic steps toward protecting and strengthening networks and networked appliances will make them less susceptible to attacks. Below are some tips and recommendations from Dahua on how to create a more secured security system.

### **Mandatory actions to be taken for basic device network security:**

#### **1. Use Strong Passwords**

Please refer to the following suggestions to set passwords:

- The length should not be less than 8 characters.
- Include at least two types of characters; character types include upper and lower case letters, numbers and symbols.
- Do not contain the account name or the account name in reverse order.
- Do not use continuous characters, such as 123, abc, etc.
- Do not use overlapped characters, such as 111, aaa, etc.

#### **2. Update Firmware and Client Software in Time**

- According to the standard procedure in Tech-industry, we recommend to keep your device (such as NVR, DVR, IP camera, etc.) firmware up-to-date to ensure the system is equipped with the latest security patches and fixes. When the device is connected to the public network, it is recommended to enable the "auto-check for updates" function to obtain timely information of firmware updates released by the manufacturer.
- We suggest that you download and use the latest version of client software.

### **"Nice to have" recommendations to improve your device network security:**

#### **1. Physical Protection**

We suggest that you perform physical protection to device, especially storage devices. For example, place the device in a special computer room and cabinet, and implement well-done access control permission and key management to prevent unauthorized personnel from carrying out physical contacts such as damaging hardware, unauthorized connection of removable device (such as USB flash disk, serial port), etc.

#### **2. Change Passwords Regularly**

We suggest that you change passwords regularly to reduce the risk of being guessed or cracked.

#### **3. Set and Update Passwords Reset Information Timely**

The device supports password reset function. Please set up related information for password reset in time, including the end user's mailbox and password protection questions. If the information changes, please modify it in time. When setting password protection questions, it is suggested not to use those that can be easily guessed.

#### **4. Enable Account Lock**

The account lock feature is enabled by default, and we recommend you to keep it on to guarantee the account security. If an attacker attempts to log in with the wrong password several times, the corresponding account and the source IP address will be locked.

#### **5. Change Default HTTP and Other Service Ports**

We suggest you to change default HTTP and other service ports into any set of numbers between 1024–65535, reducing the risk of outsiders being able to guess which ports you are using.

#### **6. Enable HTTPS**

We suggest you to enable HTTPS, so that you visit Web service through a secure communication channel.

## 7. **MAC Address Binding**

We recommend you to bind the IP and MAC address of the gateway to the device, thus reducing the risk of ARP spoofing.

## 8. **Assign Accounts and Privileges Reasonably**

According to business and management requirements, reasonably add users and assign a minimum set of permissions to them.

## 9. **Disable Unnecessary Services and Choose Secure Modes**

If not needed, it is recommended to turn off some services such as SNMP, SMTP, UPnP, etc., to reduce risks.

If necessary, it is highly recommended that you use safe modes, including but not limited to the following services:

- SNMP: Choose SNMP v3, and set up strong encryption passwords and authentication passwords.
- SMTP: Choose TLS to access mailbox server.
- FTP: Choose SFTP, and set up strong passwords.
- AP hotspot: Choose WPA2-PSK encryption mode, and set up strong passwords.

## 10. **Audio and Video Encrypted Transmission**

If your audio and video data contents are very important or sensitive, we recommend that you use encrypted transmission function, to reduce the risk of audio and video data being stolen during transmission.

Reminder: encrypted transmission will cause some loss in transmission efficiency.

## 11. **Secure Auditing**

- Check online users: we suggest that you check online users regularly to see if the device is logged in without authorization.
- Check device log: By viewing the logs, you can know the IP addresses that were used to log in to your devices and their key operations.

## 12. **Network Log**

Due to the limited storage capacity of the device, the stored log is limited. If you need to save the log for a long time, it is recommended that you enable the network log function to ensure that the critical logs are synchronized to the network log server for tracing.

## 13. **Construct a Safe Network Environment**

In order to better ensure the safety of device and reduce potential cyber risks, we recommend:

- Disable the port mapping function of the router to avoid direct access to the intranet devices from external network.
- The network should be partitioned and isolated according to the actual network needs. If there are no communication requirements between two sub networks, it is suggested to use VLAN, network GAP and other technologies to partition the network, so as to achieve the network isolation effect.
- Establish the 802.1x access authentication system to reduce the risk of unauthorized access to private networks.
- Enable IP/MAC address filtering function to limit the range of hosts allowed to access the device.

## More information

Please visit Dahua official website security emergency response center for security announcements and the latest security recommendations.

ENABLING A SAFER SOCIETY AND SMARTER LIVING

ZHEJIANG DAHUA VISION TECHNOLOGY CO., LTD.

Address: No. 1399, Binxing Road, Binjiang District, Hangzhou, P. R. China | Website: [www.dahuasecurity.com](http://www.dahuasecurity.com) | Postcode: 310053

Email: [dhoverseas@dhvisiontech.com](mailto:dhoverseas@dhvisiontech.com) | Tel: +86-571-87688888 28933188